

# HARVEYTILE

# INSTALLATION GUIDE

Your easy  
step-by-step  
guide to installing  
your genuine  
Harveytile roof.

For more details, consult your Harveytile installation manual.



**REMEMBER**  
The tile on Top is  
a Harveytile

Tel: +27 11 741 5600  
Fax: +27 11 813 3639  
e-mail: [info@hrp.co.za](mailto:info@hrp.co.za)  
[www.hrp.co.za](http://www.hrp.co.za)  
[www.macsteel.co.za](http://www.macsteel.co.za)

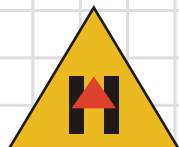

**Harvey  
Roofing Products**



# THE ROOFING SYSTEM FOR HARVEY TILES AND HARVEY ACCESSORIES

WHAT YOU WILL NEED...

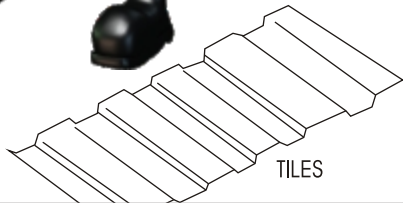
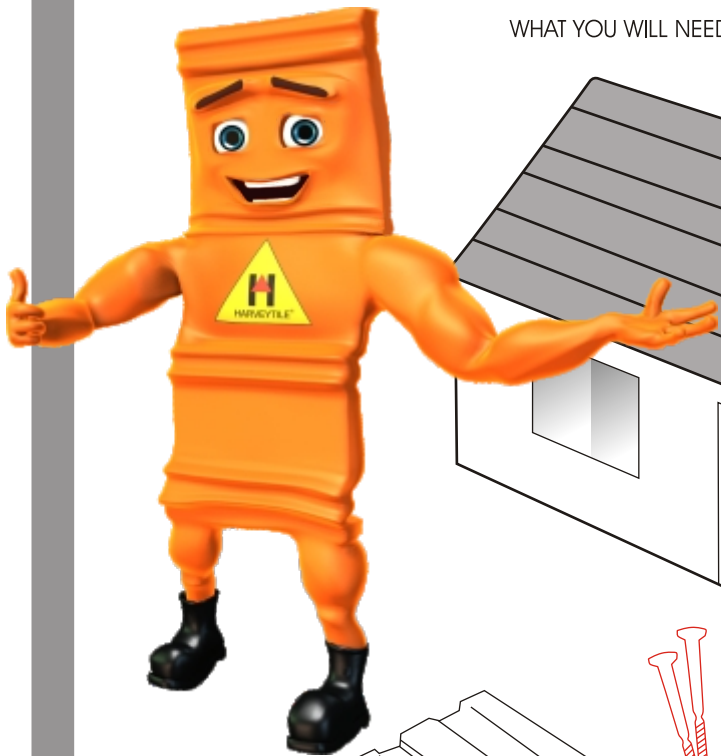

TILES

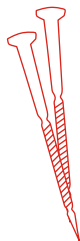

40 mm  
SERRATED  
GALVANISED  
NAILS

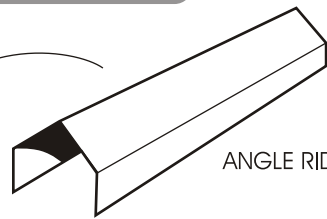

ANGLE RIDGE CAP

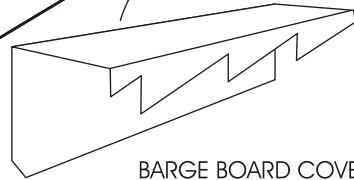
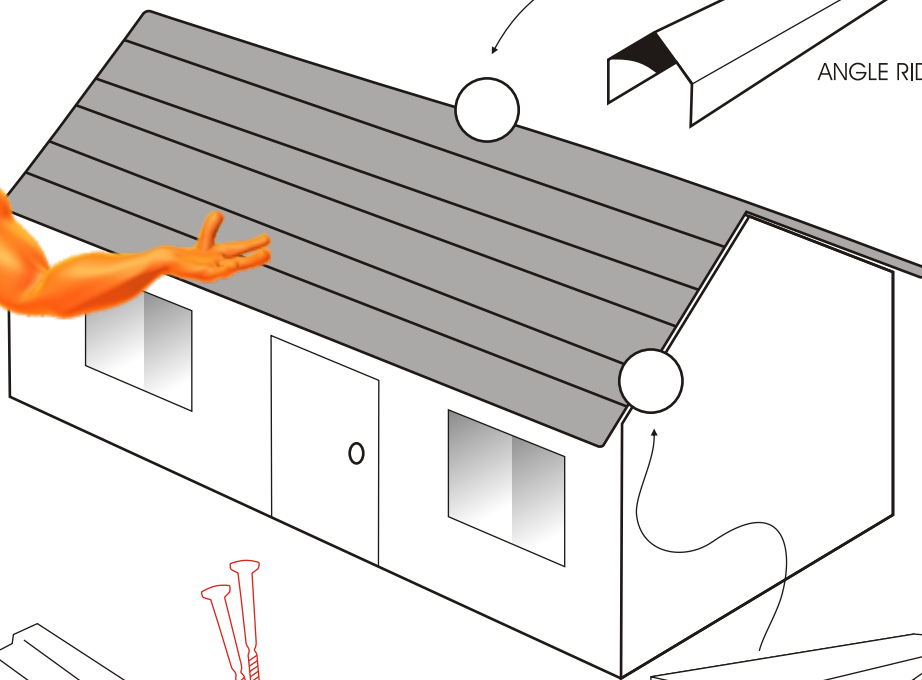

BARGE BOARD COVER

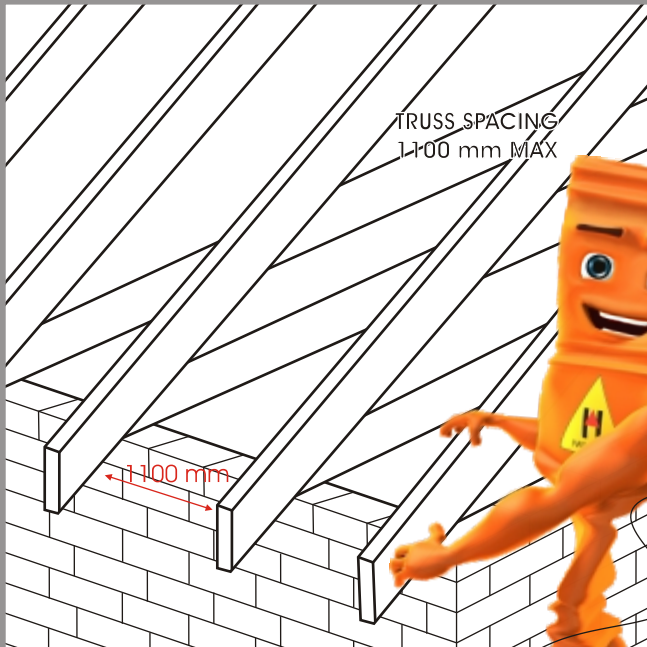

TRUSS SPACING  
1100 mm MAX

1100 mm

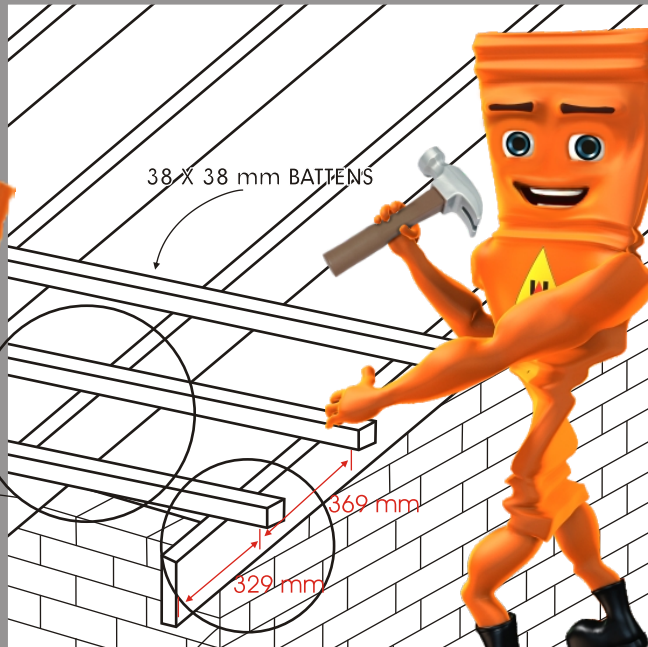

38 X 38 mm BATTENS



369 mm

329 mm

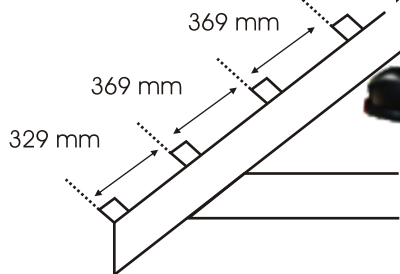

369 mm

369 mm

329 mm

NOTE THE  
BATTEN SPACING  
AT THE EAVES TO  
ALLOW FOR  
GUTTER  
OVERHANG

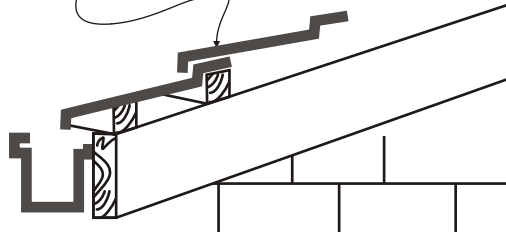

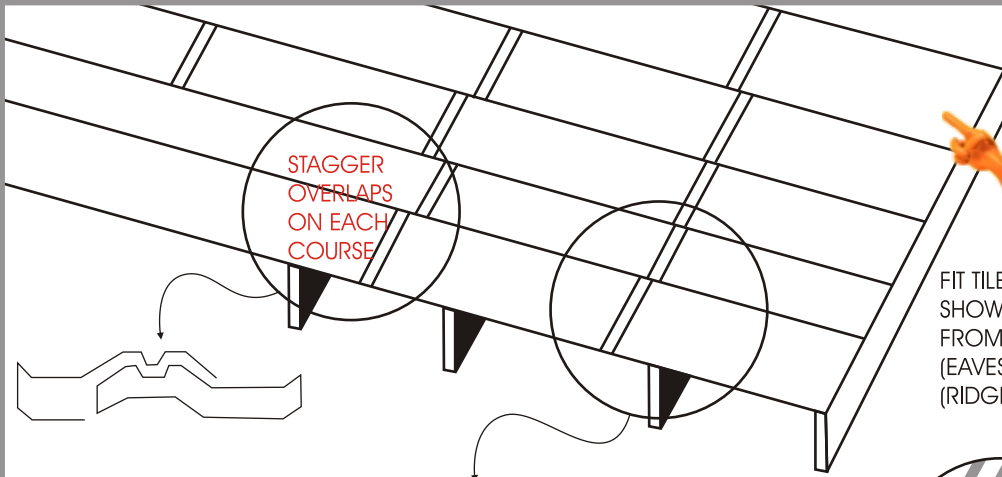

STAGGER  
OVERLAPS  
ON EACH  
COURSE

FIT TILES AS  
SHOWN WORKING  
FROM BOTTOM  
(EAVES) TO THE TOP  
(RIDGE)

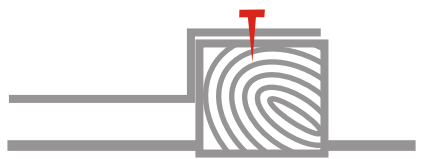
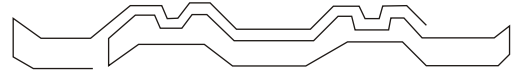

NAILING DETAIL

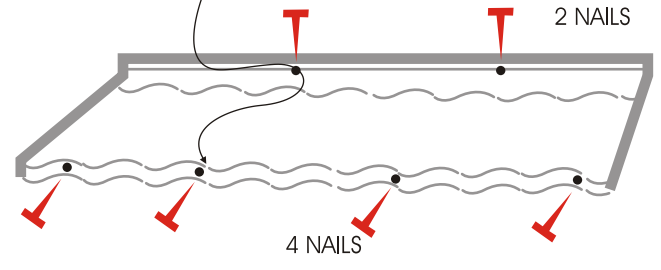
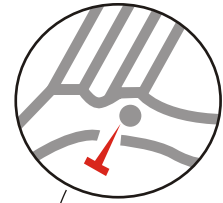
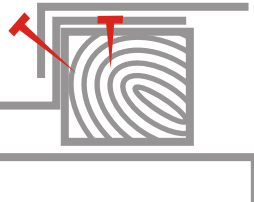

2 NAILS

4 NAILS

## FINISHING THE ROOF

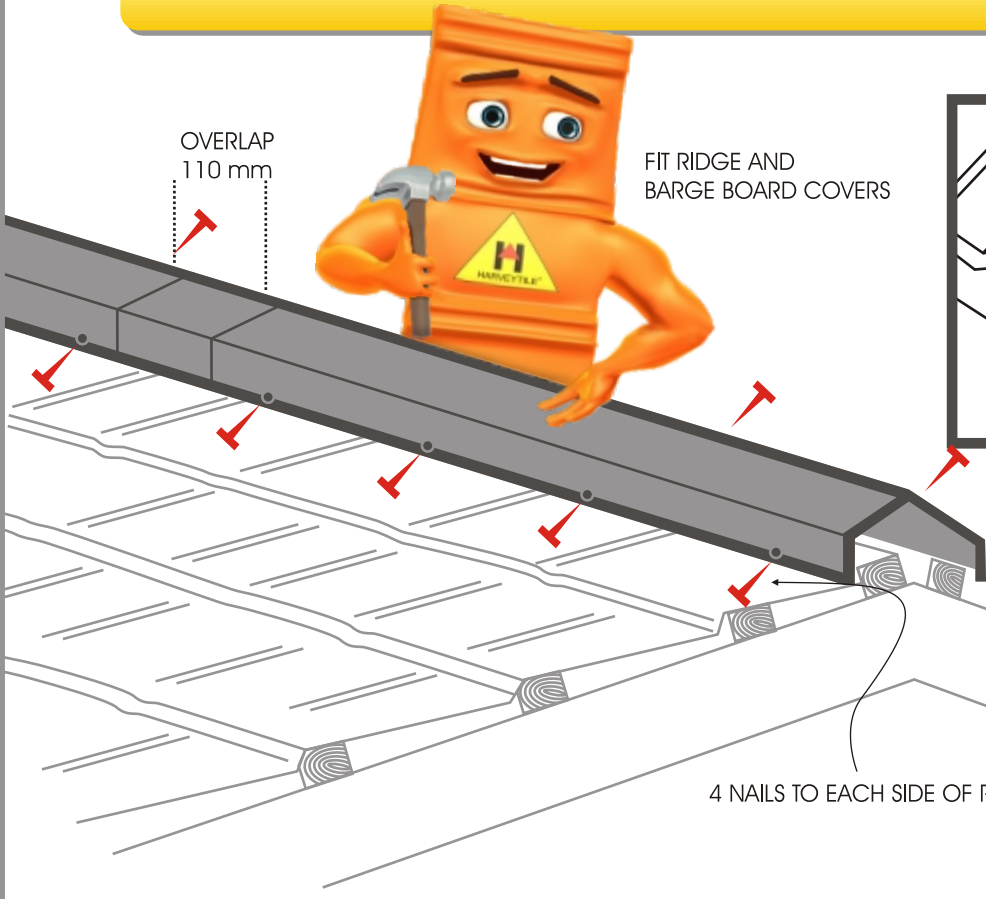

OVERLAP  
110 mm

FIT RIDGE AND  
BARGE BOARD COVERS

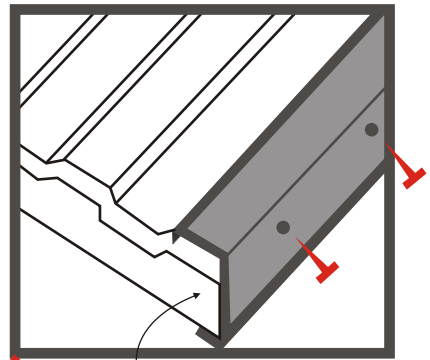

BARGE BOARD COVERS  
NAILED TO BATTENS

4 NAILS TO EACH SIDE OF RIDGE CAP



# Harveytile

## Harveytile's got you covered

- Water Proof** - you're protected against leakages or water damage
- Wind Proof** - the strongest winds will not damage a genuine Harveytile
- Hail Proof** - the strongest hail will not destroy a Harveytile
- UV Proof** - the harshest sunlight will not damage a Harveytile
- Hurricane Proof** - Even a hurricane is no match for a Harveytile



## The Tile on Top is a Harveytile

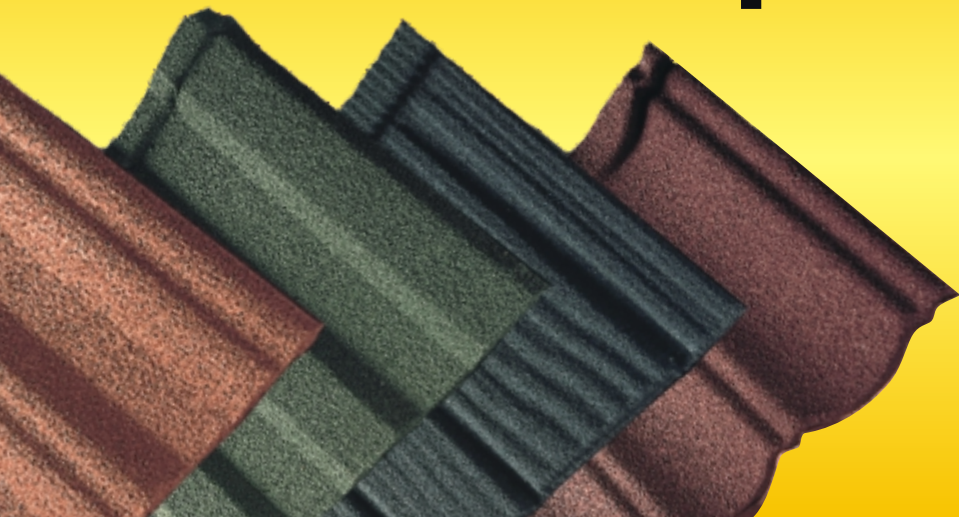

**If it doesn't say  
Harveytile,  
it's not a Harveytile**